

MONOCHROME

 **GENROSE**





12"x24" Field Tile in Statuary



12"x48" Field Tile in St. Laurent
24"x48" Field Tile in St. Laurent

AVAILABLE IN:

Field Tile *Only Available in Statuary

24"x48" Polished Finish
 12"x48" Polished Finish
 40"x40" Polished Finish*
 36"x36" Polished | Matte Finish*
 18"x36" Polished | Matte Finish*
 32"x32" Polished Finish*
 16"x32" Polished Finish*
 24"x24" Polished Finish
 12"x24" Polished Finish
 12"x12" Polished Finish*

Mosaics

3"x12" Mosaic in Statuary Polished Finish
 2"x2" Mosaic in Statuary Polished | Matte Finish
 1"x1" Mosaic Polished Finish
 Cube Mosaic Polished Finish





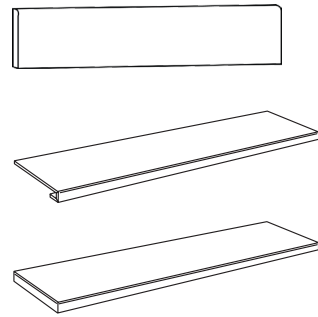



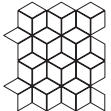

Trim Pieces

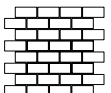
3¹/₅x32" Baseboard in Statuary Polished Finish
 3"x24" Baseboard Polished Finish
 13"x12" Step Polished Finish
 13"x12" Corner Step Polished Finish

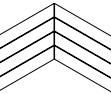
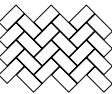

MADE TO ORDER FIELD TILES AND MOSAICS:

This represents a small portion of the mosaic patterns we offer.
 We can cut any field tile to create a custom mosaic or field tile size as specified.

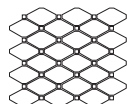
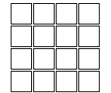
FIELD TILES		CUBES		BASKETWEAVE	
	Any 24" field tile can be cut down to a smaller size in any length and width combination with a 1" minimum.		2" 4"		1 ³ / ₈ "x3" 2"x4"
		BRICKS		DIAMONDS	
			1"x2" 1"x3" 1 ³ / ₈ "x3" 2"x4"		2"
FIELD SHAPES*		CHEVRONS		HERRINGBONE	
 Half Hexagon	6.7" Base		2"x12"		1"x2" 2"x4" 5 ¹ / ₈ "x4"
 Diamond	4"	OCTAGONS		HEXAGONS	
 Hexagon	6"		2" w/ 0.6" Squares		1 ¹ / ₈ " 2"
 Chevron	2"x12" 6"x24"	SQUARES		RECTANGLES	
 TRAPEZOID W/ DOT	4"x2 ¹ / ₂ " w/ 5 ¹ / ₈ " Dot		1"x1" 1 ³ / ₈ "x1 ³ / ₈ "	2"x2" 3"x3"	1"x2" 1"x4"

*Other sizes available upon request



St. Laurent



Pietra Grey

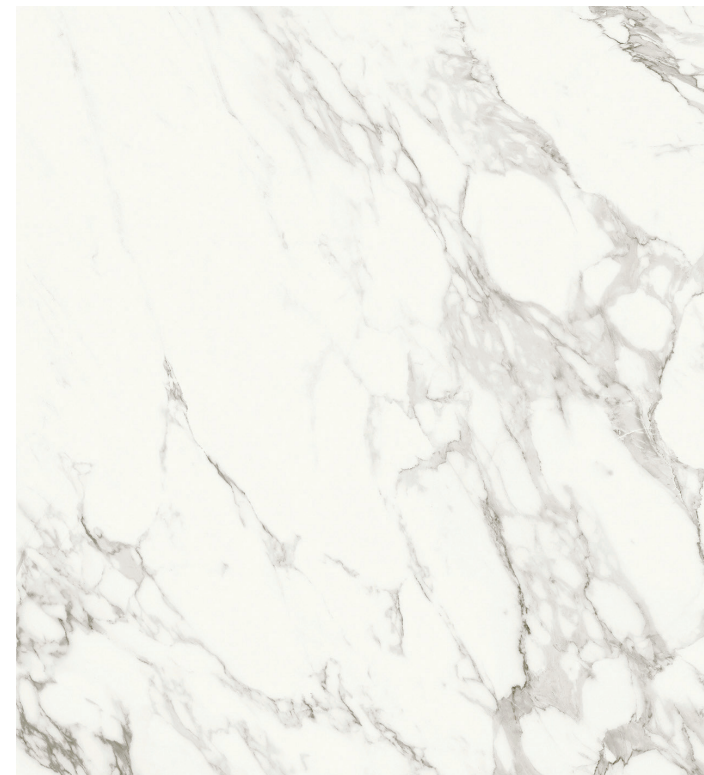

Statuary

3"X12" MOSAIC



Statuary

CUBE MOSAIC



1"X1" MOSAIC



Statuary

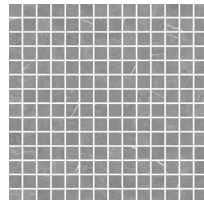

Pietra Grey

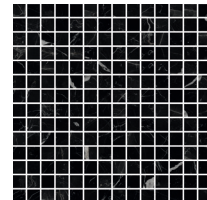

St. Laurent

2"X2" MOSAIC

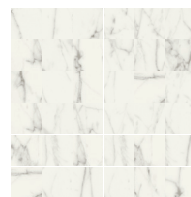

Statuary

Features	Test Method	Value		
Reaction to Fire	Decision 96/603/CEE as amended	A1 _{fl}		
Water Absorption	ISO 10545-3	≤0.5%		
Bending Strength	ISO 10545-4	S >700 N for thickness < 7,5 mm R >35 N/mm ² for thickness < 7,5 mm S >1300 N for thickness ≥ 7,5 mm R >35 N/mm ² for thickness ≥ 7,5 mm		
Thermal Shock Resistance	ISO 10545-9	Resistant		
Frost Resistance	ISO 10545-12	Resistant		
Resistance of Chemical Attack	ISO 10545-13	High Concentration	Low Concentration	Domestic Chemicals
		Resistant	Resistant	Compliant
Stain Resistance	ISO 10545-14	Class 5		

Product Info:

- Porcelain Tile
- Polished Finish
- Frost Resistance = Yes
- Contact your sales representative for more information





www.genrose.com